

MARINER 90 JD TS



Control panel



1500 rpm John Deere engine



Input/Output fuel pipe



Unit of measure: mm

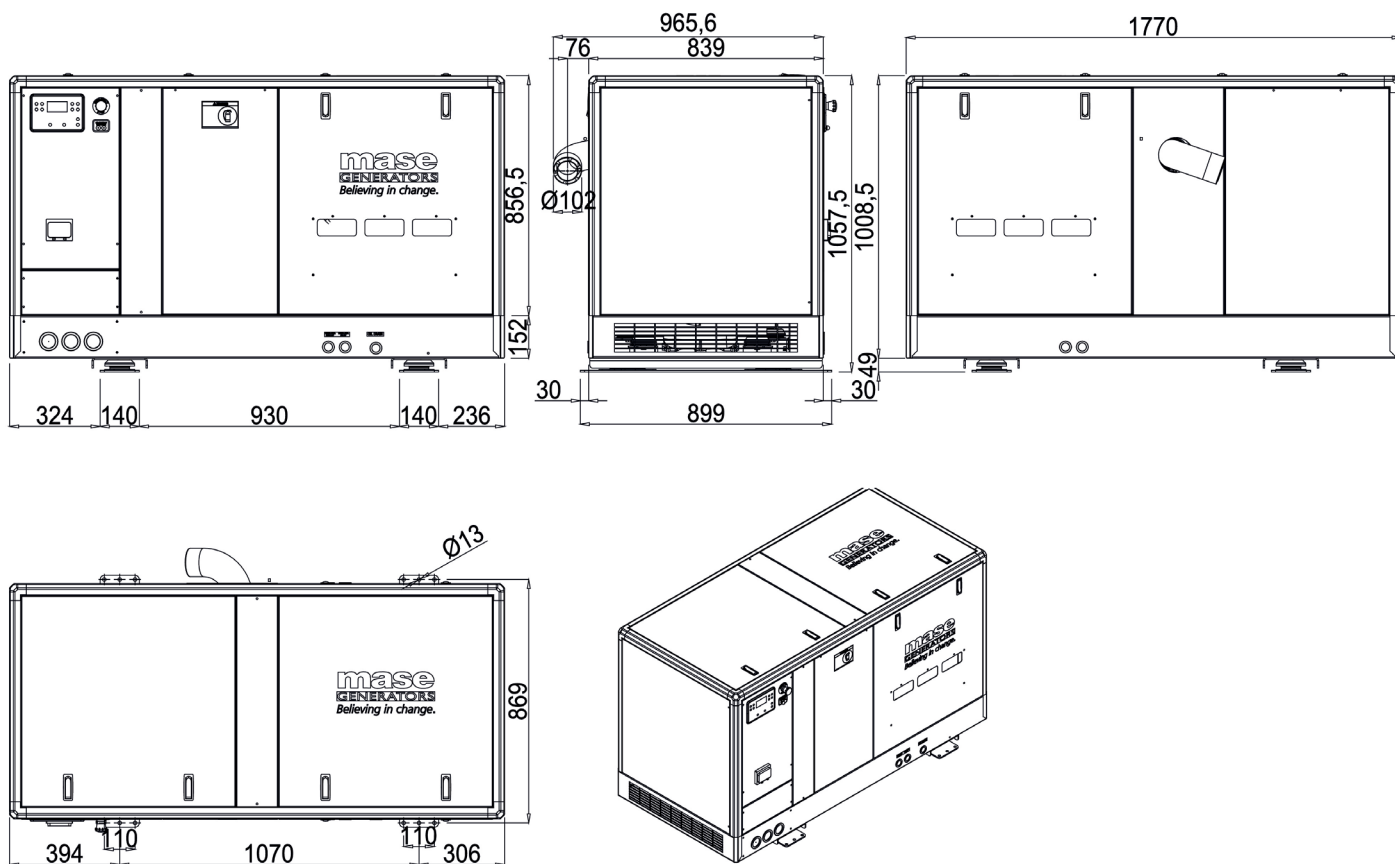

We reserve the right to change data, images and drawings without notice.
For more information, you may contact your local dealer or Mase Generators S.p.A.

Mase Generators spa

Via Tortona, 345 - 47522 - Cesena (FC) - Tel. +39 0547 354311

www.masegenerators.com - commercial@masegenerators.com

mase
GENERATORS
Believing in change.



Output power 88 kVA three-phase

Description

- Marine power generator
- 1500 rpm Diesel engine
- Silenced version

AC generator - 50Hz

- Type: synchronous, 4 poles, self-excited, brushless, with AVR
- Cooling: air
- Max. power: 88 kVA
- Continuous power: 80 kVA
- Voltage (V): 400
- Amps: 127,16
- Power factor: $\cos \phi$ 0,8
- Voltage stability: $\pm 2\%$
- Frequency stability: $\pm 5\%$

Diesel Engine 1500 rpm

- Type: John Deere 4045AFM85 - 4 cyl. - 119 hp (89 kWm) - 4500 cm³
- Starting system: electric (12Vdc)
- Fuel consumption @ 100%: 23,5 lt/h ca.
- Easy access in case of maintenance of feeding system, lubrication system, sea/water pump and air filter
- Safety stop in case of low oil pressure
- Safety stop in case high water temperature or high exhaust gas temperature
- Oil filter and fuel filter easy to replace

Standard Features

- Controller with digital display for full monitoring of generator parameters: manual start, Vac voltage, frequency Hz, power, amperage, engine rpm, hourmeter, genset battery voltage, engine oil pressure, low oil pressure alarm, engine temperature, engine pre-heating, high engine temperature warning and shutdown alarm, high alternator temperature warning and shutdown alarm, alternator battery charger failure alarm, inverter failure alarm, protection alarm for Overload, short circuit, high and low voltage, high and low frequency, high and low rpm, alarms history, maintenance warning
- Other features: direct ECU communication via CAN line, possibility to disable all protections (emergency mode operation), automatic start for low battery voltage level, possibility for a Start/Stop remote switch (AUT mode), possibility to have multiple remote devices
- Emergency stop button
- Thermal and magneto-thermal protection

Accessories on request

- Siphon break
- Filter kit
- Exhaust kit
- Separator and exhaust advice
- Remote START/STOP panel (20 mt cable)
- Remote start panel with display (20 mt cable)
- Insulated two poles kit

Noise level

- 58 dBA @ 7mt

Other features

- Insulation Class: H
- Ambient temperature: 40 °C (*)
- Altitude: 1000 mt (*)
- Mechanical Protection: IP 23
- Dimensions (L x W x H): 1770 x 966 x 1058 mm
- Dry weight: 1234 Kg
- Max. inclination: 30°
- Water pump flow (l/min): 155
- Cooling system: cupronickel exchanger (heat exchange between coolant liquid and sea water)
- Soundproof cabin made of extremely light marine aluminum with very high resistance to external agents

(*) - For altitude and temperature values other than those listed above, please consult the manufacturer to verify the available power.